



MHCCW-08-05 Chilled Water Ceiling Concealed With **5kW** Electric Heat

2-Pipe Heat / Cool Fan Coil 24,000 BTUH

HVAC Guide Specifications

Chilled or Hot Water Fan Coil with Electric Heat
2-Pipe

Nominal Size:

24,000 BTUH

MultiAqua Model Number:

MHCCW-08-05

Part 1-General

1.01 System Description

MultiAqua Chilled Water Fan Coils are manufactured with heavy gauge galvanized steel to resist corrosion.

1.02 Quality Assurance

- A. Certified in accordance with U.L. Standard 95, latest version (U.S.A.)
- B. Manufactured in a facility registered to ISO 9002, Manufacturing Quality Standard.
- C. Fully load tested at the factory.
- D. Damage resistant packaging.

1.03 Delivery, Storage and Handling

- A. Packaged and readied for shipment from the factory.
- B. Controls shall be capable of withstanding 150°F storage temperatures in the control compartment.
- C. Stored and handled per manufacturer's recommendations.

Part 2-Product

2.01 Equipment

A. General:

1. Unit shall be a factory assembled and tested chilled or hot water fan coil with electric heat.
2. Shall be assembled with heavy gauge galvanized steel.
3. Contained with the unit shall be all factory wiring, piping, associated controls and special accessories required prior to start up.

B. Unit Cabinet:

1. Composed of heavy gauge galvanized steel casing with a baked polyester powder.
2. Shall be internally insulated to ensure quiet operation.

C. Fan Motors:

1. Shall be available in 208/230-1-50/60 VAC.
2. Fan motors shall be three speed, direct drive, and PSC type.
3. Totally enclosed.
4. Internal overload protected.

D. Blower Wheels:

1. Blower wheels are forward curved and dynamically balanced.

E. Water Coil:

1. Manufactured with water coils containing 3/8" copper tubing mechanically bonded to aluminum fins.
2. Contain both a manual water drain and manual air bleed port per coil.
3. Coils shall be factory tested to 350 psig.
4. Coils shall be capable of being field converted from right to left hand connection.

F. Drain Pan:

1. All drain pans shall be coated on both the interior and exterior with baked polyester powder to resist corrosion.
2. The exterior of all drain pans shall be insulated with closed cell insulation to prevent condensation.
3. Pans shall contain a left and right hand primary sloped drain connection as well as a sloped right hand secondary drain connection.

G. Electric Heat:

1. Electric Heaters shall be of the rod and disk type.
2. Shall be protected by safeties.

Part 3-Controls and Safeties**3.01 Controls**

- A. Fan coils shall be completely factory wired and tested.
- B. All components shall be wired to an internal terminal block to allow for a field installed thermostat and or Fan speed control.
- C. Controls shall include the following components.
 - 1. 24vac transformer.
 - 2. Fan relays.
 - 3. Electric heat sequencer(s).
 - 4. Optional Thermostats.

3.02 Safeties

- A. Fan coil shall be equipped with all necessary components in conjunction with the control system to provide the following protectants.
 - 1. High temperature.
 - 2. Over current protection.

Part 4-Operating Characteristics:**4.01 Electrical Requirements**

- A. Primary electrical power supply shall enter the unit at a single location.
- B. Electrical power supply shall be rated to withstand 120°F operating ambient temperatures.
- C. Control and high voltage points shall be accessed through terminal block.

Part 5- Accessories:**5.01 Enclosures**

- A. Fan coils shall be capable of incorporating field assembled enclosures.
 - 1. Enclosures shall be internally insulated to ensure quiet operation and increase efficiency.
 - 2. Shall include knockouts for ease of piping and electrical in and out of the enclosures.
 - 3. Shall include an optional return air cutout in the enclosure.
 - 4. Shall include a supply air duct flange.
 - 5. Shall incorporate baked polyester powder service access panels with and without a filtered louver

Part 6- Definitions:**6.01 Abbreviations**

- A. CFM = Cubic Feet per Minute
- B. DB = Dry Bulb Temperature
- C. EWT = Entering Water Temperature
- D. GPM = US Gallons Per Minute
- E. MBH = BTU X 1000
- F. SC = Sensible Cooling
- G. TC = Total Cooling = Sensible + Latent
- H. WB = Wet Bulb Temperature
- I. WPD = Water Pressure Drop in feet of head
- J. dB = Decibel Level
- K. m = Meter
- L. In = Inches
- M. FPI = Fins per Inch
- N. OD = Outside Diameter
- O. ID = Inside Diameter
- P. MCA = Minimum Circuit Amps
- Q. MOP = Maximum Over current Protection
- R. LBS = Pounds U.S.

6.02 Measurements

- A. All measurements with regard to length, width, and height shall be in inches

MHCCW-08-05 Product Specifications

Physical Data

Model Number	Height (in)	Width (in)	Depth (in)	Weight (lbs.)	Coil Rows FPI	Copper Diameter (in)	Water Inlet (in)	Water Outlet (in)	Drain (in)
MHCCW-08-05	10.25	37.72	21.65	72.6	4-14	3/8	5/8	5/8	3/4

Electrical Data

Model Number	Nominal CFM	Volts Phase Hertz	Electric Heat (KW)	Fan Motor HP	Full Load Ampacity	Fuse or HACR Circuit Breaker Per Circuit	
						MCA	MOP
MHCCW-08-05	850	208/230-1-50/60	5	1/4	23.17	32.36	35

External Static Pressure Comparative CFM Table

Model Number	0.00*	0.05*	0.10*	0.15*	0.2*	0.25*	0.30*
MHCCW-04	322	290	252	220	0	0	0
MHCCW-06	715	684	653	622	591	565	538
MHCCW-08	915	879	814	809	774	734	693
MHCCW-10	1007	975	944	898	853	817	780
MHCCW-12	1254	1218	1183	1147	1112	1076	1041
MCCW-16	1435	1394	1354	1313	1272	1231	1191
MCCW-20	1450	1409	1368	1327	1285	1244	1203

* External static pressure (In W.G.)

MHCCW-08-05 Chilled Water Performance Data

MHCCW-08-05 COOLING CAPACITIES				
CFM	EWT (°F)	GPM	ENTERING AIR TEMPERATURE (F)	
				80° D.B. / 67° W.B.
850	42	3.0	TC	22166
			SC	17616
			WPD	4.7
		4.0	TC	25835
			SC	19239
			WPD	8.1
		5.0	TC	28661
			SC	20523
			WPD	12.3
		6.0	TC	30770
			SC	21481
			WPD	17.3

***High Speed**

MHCCW-08-05 COOLING CAPACITIES				
CFM	EWT (°F)	GPM	ENTERING AIR TEMPERATURE (F)	
				80° D.B. / 67° W.B.
850	45	3.0	TC	19943
			SC	16731
			WPD	4.7
		4.0	TC	23041
			SC	18086
			WPD	8.0
		5.0	TC	25412
			SC	19211
			WPD	12.2
		6.0	TC	27377
			SC	20111
			WPD	17.2

***High Speed**

Recommended minimum flow rate for this unit at ≥ 2 fps is 2.75 gpm

Recommended maximum flow rate for this unit at ≤ 6 fps is 7.75 gpm

MHCCW-08-05 Hot Water Performance Data

MHCCW-08-05 HOT WATER CAPACITIES													
ENTERING AIR (°F)	NOMINAL CFM	GPM	WPD	ENTERING WATER TEMPERATURE (°F)									
				90°	100°	110°	120°	130°	140°	150°	160°	170°	180°
50	850	3.0	4.4	23645	29611	35616	41653	47717	53801	59902	66015	72137	78265
		4.0	7.6	25362	31761	38197	44663	51153	57663	64188	70725	77271	83823
		5.0	11.5	26460	33131	39835	46566	53320	60092	66877	73674	80478	87289
		6.0	16.2	27218	34073	40958	47869	54799	61746	68705	75675	82652	89634

MHCCW-08-05 HOT WATER CAPACITIES													
ENTERING AIR (°F)	NOMINAL CFM	GPM	WPD	ENTERING WATER TEMPERATURE (°F)									
				90°	100°	110°	120°	130°	140°	150°	160°	170°	180°
60	850	3.0	4.4	17847	23791	29777	35796	41842	47911	53998	60099	66210	72327
		4.0	7.6	19117	25494	31909	38356	44830	51325	57836	64361	70896	77439
		5.0	11.5	19929	26578	33263	39977	46714	53472	60245	67030	73824	80626
		6.0	16.1	20489	27324	34191	41085	48001	54934	61882	68841	75808	82782

MHCCW-08-05 HOT WATER CAPACITIES													
ENTERING AIR (°F)	NOMINAL CFM	GPM	WPD	ENTERING WATER TEMPERATURE (°F)									
				90°	100°	110°	120°	130°	140°	150°	160°	170°	180°
70	850	3.0	4.4	12030	17953	23919	29920	35951	42006	48080	54168	60269	66377
		4.0	7.5	12857	19212	25608	32037	38495	44975	51473	57987	64511	71044
		5.0	11.4	13385	20014	26679	33376	40099	46842	53603	60376	67161	73953
		6.0	16.1	13750	20565	27415	34293	41194	48114	55050	61999	68957	75923

MHCCW-08-05 HOT WATER CAPACITIES													
ENTERING AIR (°F)	NOMINAL CFM	GPM	WPD	ENTERING WATER TEMPERATURE (°F)									
				90°	100°	110°	120°	130°	140°	150°	160°	170°	180°
80	850	3.0	4.4	6193	12097	18045	24030	30046	36087	42149	48227	54317	60417
		4.0	7.5	6582	12917	19295	25708	32150	38616	45102	51604	58118	64642
		5.0	11.4	6831	13440	20088	26768	33476	40206	46955	53718	60492	67276
		6.0	16.1	7003	13799	20632	27494	34382	41290	48214	55153	62102	69060

Heating at ANSI/AHRI 440 with addendum 1, 6.3.2 Table 1 as follows:

ENTERING AIR TEMPERATURE	GPM	ENTERING WATER TEMPERATURE 140F
70F DB / 60F WB	3.0	42250
	4.0	45274
	5.0	47181
	6.0	48482

MHCCW-08-05 Electric Heat Performance Data

Model Number	Nominal CFM	Electric Heat BTUH
MHCCW-08-05	850	17,000

MHCCW-08-05 Sound Data

MODEL #	MHCCW-08-05
Fan Speed	dB @ 1 m
H	46

MHCCW-08-05 Dimensional Drawing

MHCCW Certified Drawing
 Drawing # 0907400070

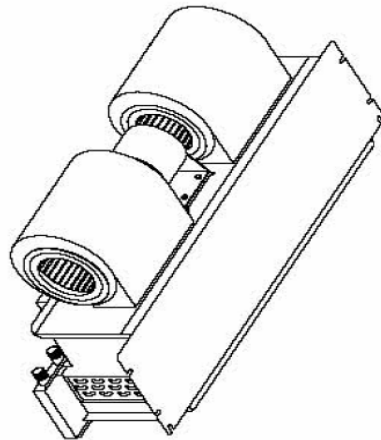
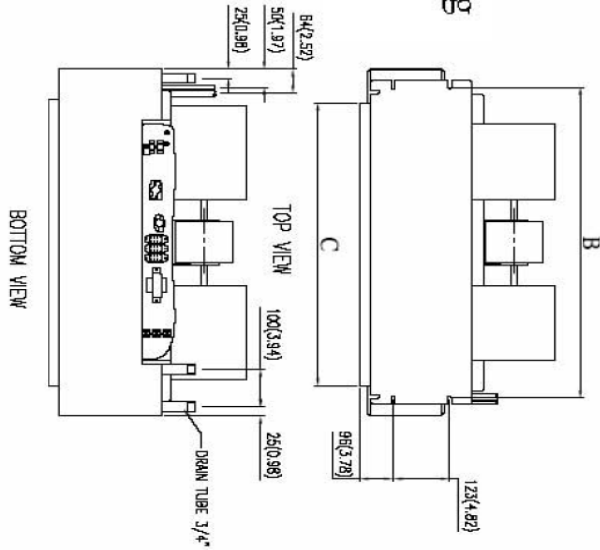
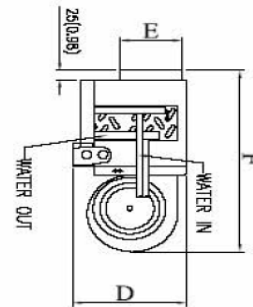
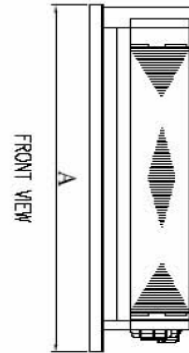
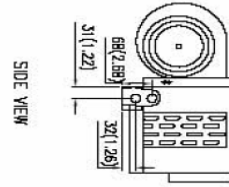

Model MHCCW

MODEL	A	B	C	D	E	F
04	958(37.72)	878(34.57)	798(31.42)	260(10.24)	140(5.51)	550(21.65)
06	958(37.72)	878(34.57)	798(31.42)	260(10.24)	140(5.51)	550(21.65)
08	958(37.72)	878(34.57)	798(31.42)	260(10.24)	140(5.51)	550(21.65)
10	1110(43.70)	1030(40.55)	950(37.40)	260(10.24)	140(5.51)	550(21.65)
12	1262(49.69)	1182(46.54)	1102(43.38)	260(10.24)	140(5.51)	550(21.65)