

# MHCCW-12-05 with Electric Heat Wiring Diagram

208/230/-1-50/60

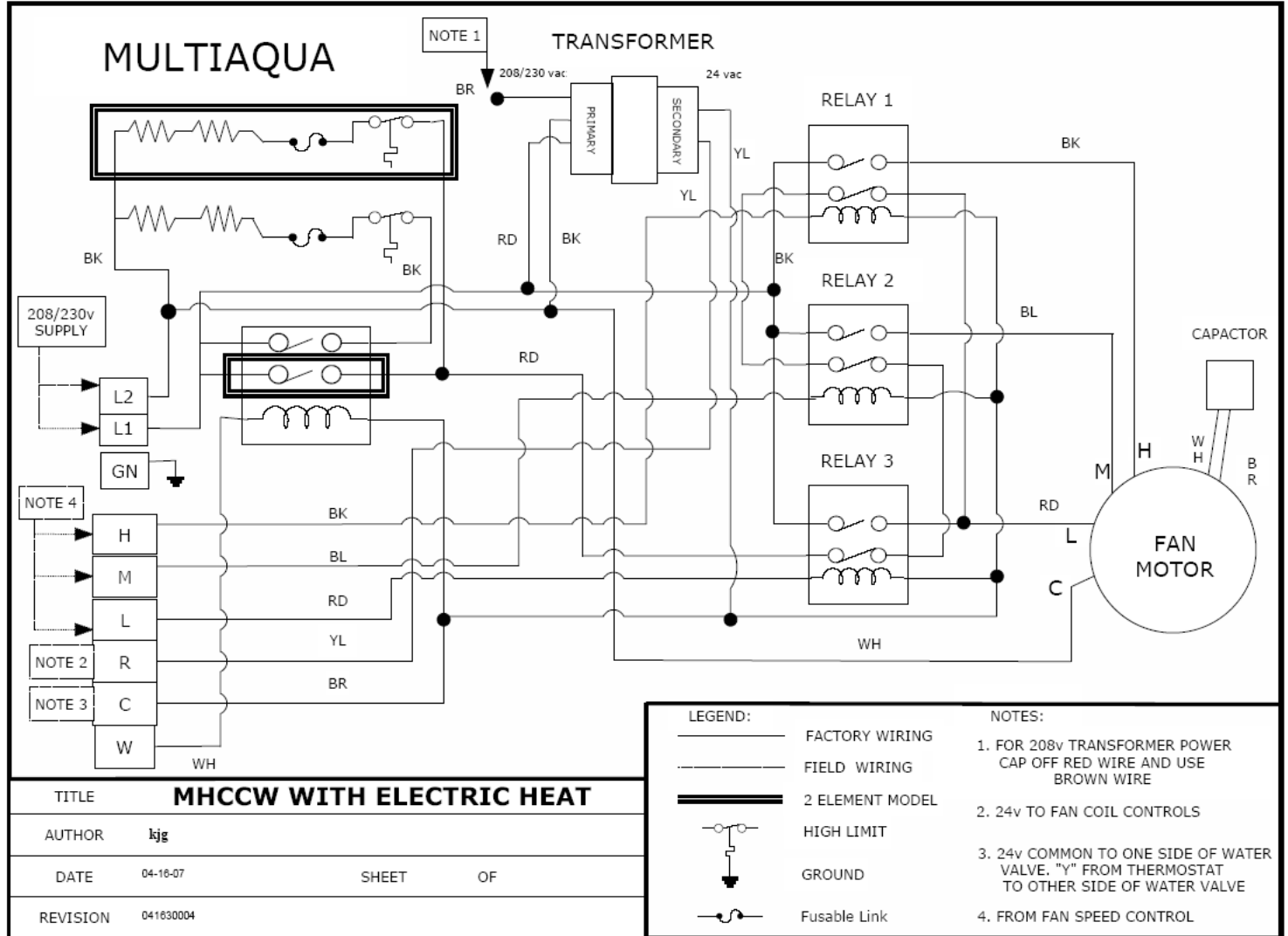

# MHCCW-12-05 Dimensional Drawing

MHCCW Certified Drawing  
 Drawing # 0907400070

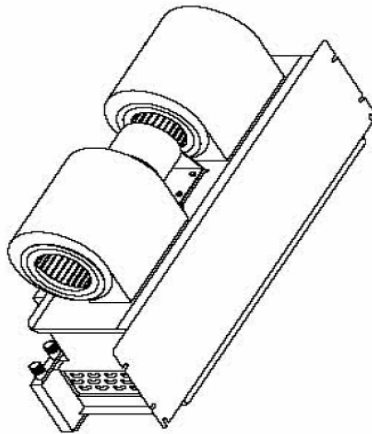
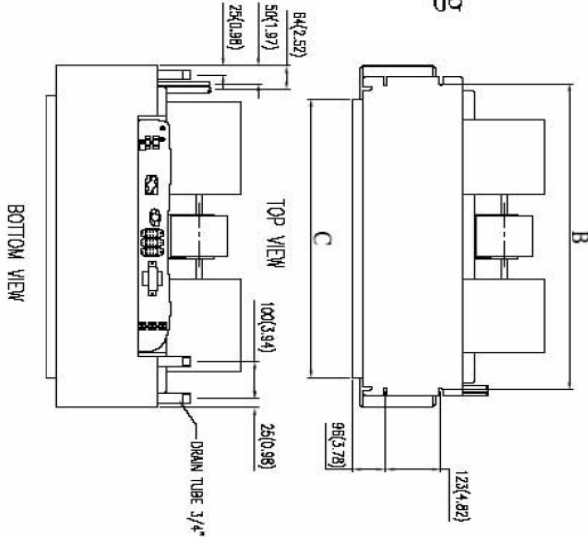
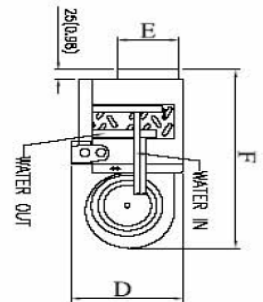
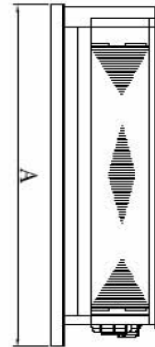
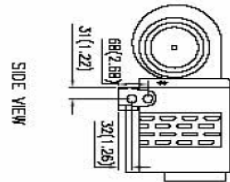

Model MHCCW

MODEL	A	B	C	D	E	F
04	958(31.72)	878(34.57)	798(31.42)	260(10.24)	140(5.51)	550(21.65)
06	958(31.72)	878(34.57)	798(31.42)	260(10.24)	140(5.51)	550(21.65)
08	958(31.72)	878(34.57)	798(31.42)	260(10.24)	140(5.51)	550(21.65)
10	1110(43.70)	1030(40.55)	950(37.40)	260(10.24)	140(5.51)	550(21.65)
12	1262(49.69)	1182(46.54)	1102(43.38)	260(10.24)	140(5.51)	550(21.65)