

# Multi aqua™

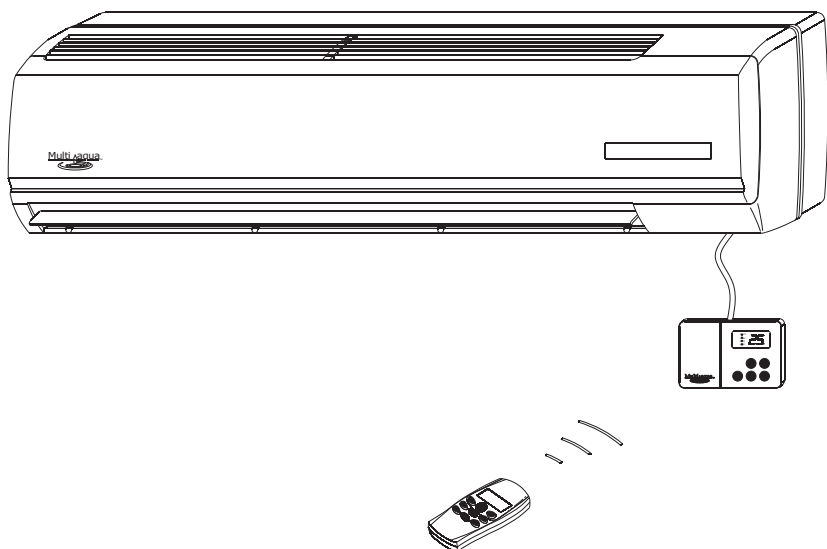

## WALL-MOUNTED FANCOIL UNIT AIR CONDITIONER



MHQWW-xx-H-1-U 208V-230V-50/60Hz

## Installation & Operation

## Instruction Manual

Please read this manual carefully before operating the unit.

# CONTENTS

Warning and Caution . . . . .	1
Preparations Before Installation . . . . .	2
Main Components . . . . .	2
Installation Procedure . . . . .	3
Thermostat Control Installation Guide . . . . .	9
Wiring Diagram . . . . .	11
Wired Controller Operation Guide . . . . .	15
Remote Controller Operation Guide . . . . .	16
Start-up Notice . . . . .	18
Adjusting Air Flow Direction . . . . .	19
Maintenance & Care . . . . .	19
Operation Tips . . . . .	20
Trouble Shooting Guide . . . . .	21
Important Information . . . . .	22

P/N:	REV
AC1700080	080

## WARNING AND CAUTION



1. Do not store or unpack the unit in a wet area or expose to rain or water.

\* May cause the unit to short circuit and may result in electric shocks or fire.

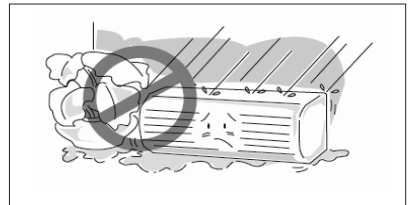

2. Do not install in a place where flammable gas may leak.

\* it may cause fire.

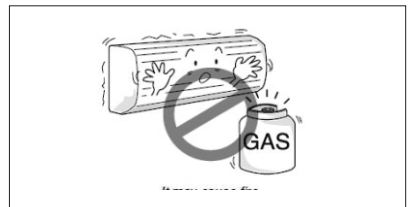

3. This unit is designed for residential and commercial use only.

\* if used in certain environments, such as a manufacturing workplace, the air conditioner may not function efficiently.



## PREPARATIONS BEFORE INSTALLATION



### READ ALL SAFETY INFORMATION BEFORE INSTALLATION:

- \* Installations must be performed by a qualified technician.
- \* Before carrying out installation, put on proper individual protection device(s).
- \* This air conditioner must be properly installed in accordance with the Installation Manual.
- \* Check all local codes and ordinances that could affect installation of this unit.
- \* Refer to rating plate on each unit for the correct voltage, frequency and amperes.
- \* Be sure that the power supply corresponds to the specified rating in the nameplate.
- \* Check electrical service provided by utility for the site to be sure the electrical service capacity can handle the load imposed by this unit.
- \* Do not use extension cords. In the case extended cables are needed, install longer power cord from terminal block.
- \* Refer to dimensional drawings for location of liquid solution piping, condensate drain, and electrical connections before setting in place.
- \* The appliance shall be installed in accordance with national and local wiring regulations.
- \* This appliance is not intended for use by persons not experienced or knowledgeable on this product
- \* Means for disconnection must be incorporated in the fixed wiring in accordance with the wiring rules and local codes.



- **THIS PRODUCT MUST BE PROPERLY GROUNDED.**
- Moving machinery and electrical power is hazardous. It may cause severe injury or death. Turn off and disconnect the power during installation and repair before any services are attempted on the unit.
- Sharp edges and coil surfaces are a potential injury hazard. Avoid contact with them.

## MAIN COMPONENTS

### □ FAN COIL UNIT

- |                      |                        |                          |
|----------------------|------------------------|--------------------------|
| 1. Deco Panel        | 4. Air Filters         | 7. Frame Grille          |
| 2. Evaporator Coil   | 5. Remote Control Unit | 8. Thermostat Controller |
| 3. Horizontal Louver | 6. Base Pan            |                          |

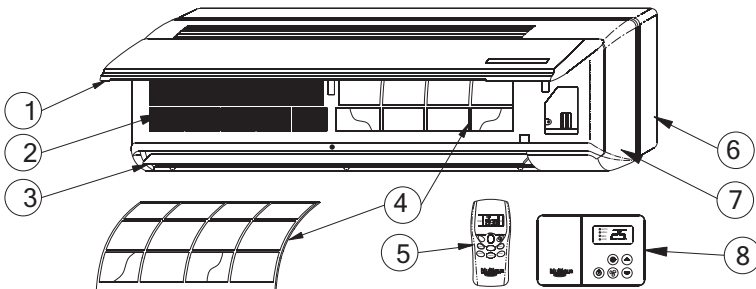

## MAIN COMPONENTS

### ■ Description of the components

1. DECO PANEL - the air intake is via the slots. When raising the panel, one has access to the air filters and the other internal parts.
2. EVAPORATOR COIL - This is made of a copper tube with turbelented type aluminum fins.
3. HORIZONTAL LOUVER - Used to deflect the air from the unit. This is operated with the step motor.
4. AIR FILTERS - To trap dirt and dust coming from the air.
5. REMOTE CONTROL - Using this makes it possible to set all operating parameters of the unit. These parameters are shown in the LCD display to make the programming operations easier.
6. BASE PAN - The base of the whole unit.
7. FRAME GRILLE - This component is attached to the deco panel and air filters Use as the cover of unit.
8. THERMOSTAT CONTROLLER - These thermostat are mercury free and require no battery. All set points are kept by non-volatile memory.

## INSTALLATION PROCEDURE

### \*LOCATION FOR FAN COIL UNIT

Select the location of fancoil unit with following consideration:

1. The front of air inlet and outlet shall be free from any obstruction.  
The outlet air should flow out freely.
2. The wall where unit is to be mounted should be strong enough to bear the weight and not to produce noise.
3. Ensure the clearance on every side of fancoil unit to conform to figure 1.
4. From floor, the height should be more than eye level.



Avoid installing the unit in direct sunlight

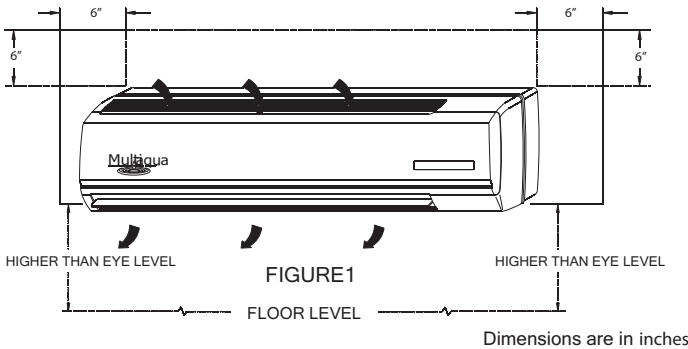

— MAINTENANCE & SERVICING SPACE

➔ AIR FLOW DIRECTION

**\*MOUNTING PLATE INSTALLATION**

1. After a suitable place for installation has been selected, place the mounting plate horizontally on the wall. Make sure the alignment is horizontal. Use a plumb line, if available.
2. Referring to the figure below, mark the location for the wall plugs and the hole for the pipings.

**PLAN DIMENSIONS FOR MOUNTING PLATE INSTALLATION**

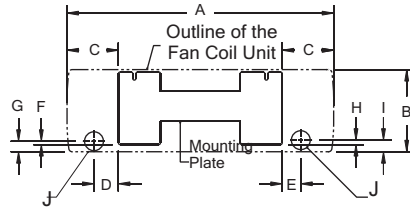

(Left, Backward Piping Hole)

(Right, Backward Piping Hole)

MODEL	A	B	C	D	E	F	G	H	I	J
MHQWW-09-H-1-U	34.6	11.7	7.5	3.5	2.7	.8	1.4	1.0	1.6	∅2.76
MHQWW-12-H-1-U	39.0	12.0	7.5	3.6	2.7	0.9	1.8	1.1	2.0	∅2.76

Dimensions are in inches.

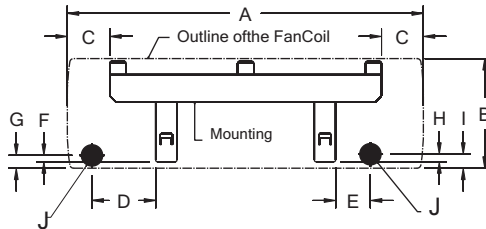

(Left, Backward Piping Hole)

(Right, Backward Piping Hole)

MODEL	A	B	C	D	E	F	G	H	I	J
MHQWW-18-H-1-U	46.0	14.2	5.5	8.3	4.5	0.8	1.7	1	1.8	∅2.76
MHQWW-24-H-1-U										

Dimensions are in inches.

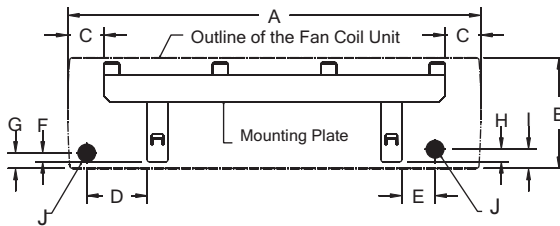

(Left, Backward Piping Hole)

(Right, Backward Piping Hole)

MODEL	A	B	C	D	E	F	G	H	I	J
MHQWW-36-H-1-U	57.1	14.4	5.8	7.9	4.5	1.2	1.8	1.3	2.0	∅2.76

Dimensions are in inches.

# INSTALLATION PROCEDURE

3. Drill 1/4 in diameter, 1-1/4 in depth on the wall.
4. Insert the wall plugs.
5. Secure the mounting plate and check for stiffness.
6. Drill a piping hole 2- 3/4 in diameter hole either from the right or to the left fancoil side and make sure that the hole is slightly slant downward.
7. If the wall is hollow please provide a sleeve for tube assembly to protect the drain line, pipings and field connection.

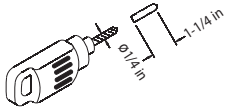

Drill diameter 1/4 in depth 1-1/4 in holes

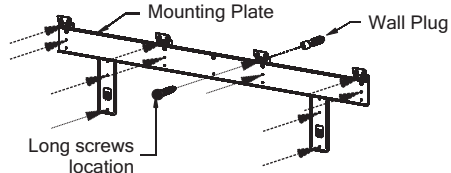

Secure mounting plate and check the stiffness.

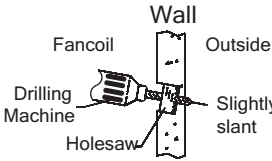

Drill a piping hole with 2-3/4 in diameter concrete drill or hole saw from fancoil side.

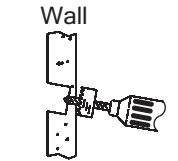

Drill from the outside

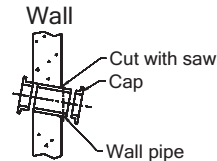

Set wall-pipe and caps (not supplied)

## \*PIPING AND DRAINAGE OF FANCOIL UNIT

1. Route the fancoil tubing with drain hose to the hole. There are four possible tubing routes. For the route 1, 2 and 4 cut the plate to pass the pipe through it, remove sharp edge left on the base pan.

### TUBING ROUTE:

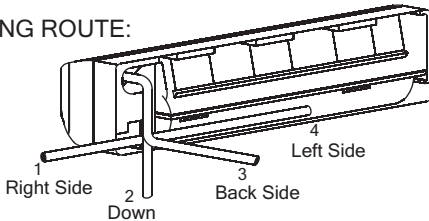

2. Insert the fancoil unit pipings and drain pipe through the hole.
3. Tape the tubing, drain hose, and connecting cable.
4. For the horizontal piping, make sure they are laid along the groove at the back of unit and secure the piping using piping clamp (2pieces) before fixing to mounting plate
5. Secure the unit to the mounting plate.

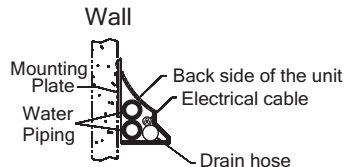
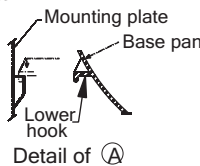
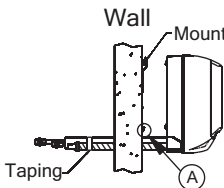

Note: Lay the drain hose as shown above

## INSTALLATION PROCEDURE

6. Connect the piping and make sure that the seals are fitted neatly.
7. Connect the drain hose and tape over the connecting parts.
8. Ensure that the drain hose has no traps or dips to impede the water flow.
9. Carefully seal any wall opening from weather to avoid any ingress of water.

### OUTSIDE OF THE WALL

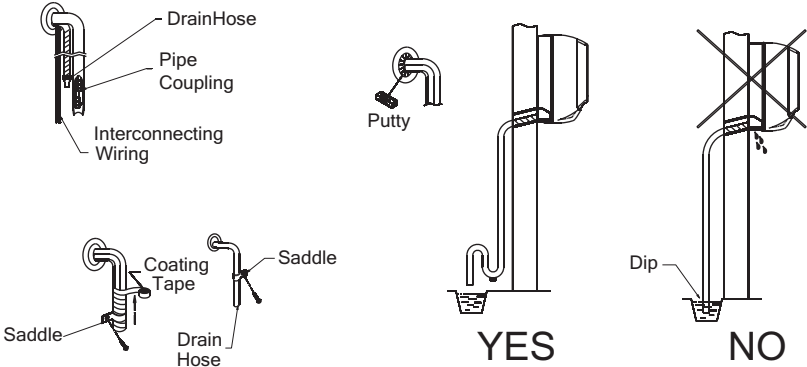

### \*FIELD PIPING CONNECTIONS

#### PIPING:

MODEL	CONNECTION	
	WATER INLET	WATER OUTLET
MHQWW-09-H-1-U & MHQWW-12-H-1-U	1/2" FLARE	1/2" FLARE
MHQWW-18-H-1-U & MHQWW-24-H-1-U	5/8" FLARE	5/8" FLARE
MHQWW-36-H-1-U	3/4" FLARE	3/4" FLARE



The piping lines must be installed level in both horizontal and vertical plane.

#### INSULATION OF PIPES:

1. The pipe insulation should cover both INLET and OUTLET pipes as shown below.
2. Use the insulation of polyethylene foam minimum of 6mm. in thickness.

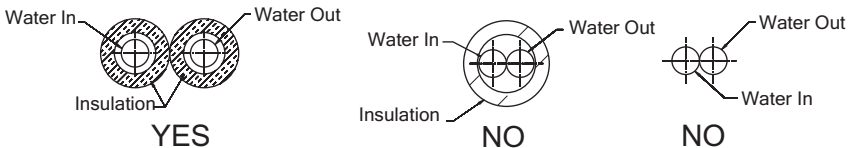

#### OPERATIONAL LIMITS:

1. Maximum inlet water temperature.....160°F
2. Maximum operating pressure.....150 PSI

**\*HOW TO REMOVE THE FRAME GRILLE**

1. Open the front panel by grasping the panel at the side rounded groove and pulling it towards you.
2. Unscrew the terminal cover and pull out as shown in the illustration

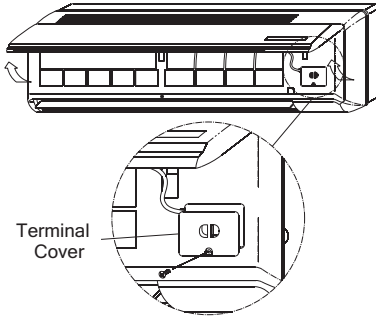

3. Remove the 3 or 4 screws cover (depended on the model) and the mounting screws of the frame grille (please refer to the illustration).

MODEL: MHQWW-09-H-1-U & MHQWW-12-H-1-U

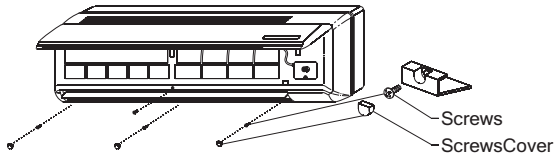

MODEL: MHQWW-18-H-1-U & MHQWW-24-H-1-U

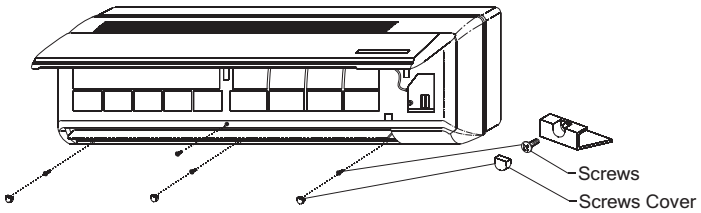

MODEL: MHQWW-36-H-1-U

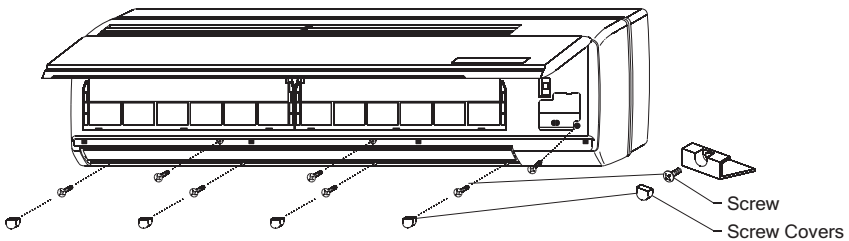



4. Set the horizontal louver to the closed position, detach horizontal louver stud on left side and push inside (please see illustration).



When performing this action, please do it gently to avoid damaging the louver.

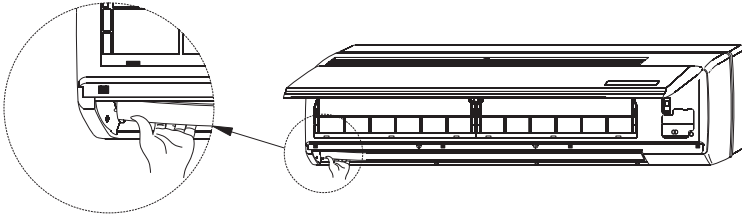

5. Open the front panel by grasping the panel at the side rounded groove and pulling it towards you.
6. Grasp the lower part of the frame grille and pull it out.

### \*CHECKING THE DRAINAGE

1. Turn off power to the unit.
2. Pour a glass of water into the drain pan.
3. Ensure that the water flows out from the drain hose off an coil unit.

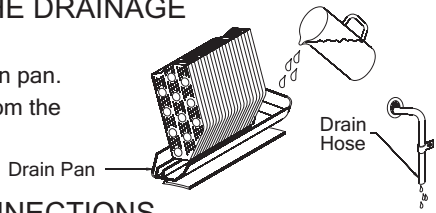

### \*WIRING CONNECTIONS



\*Be sure to turn off the main power supply before open the frame grille for servicing.

\*Always refer to the wiring diagrams inside the unit.

\*Check local electrical codes and also any specific wiring codes.

Connect the unit to adequate power outlet.

(Rating voltage  $\pm 10$  during operation)

Adequate Power Outlet

Time delay fuse or Circuit Breaker	Amp.	Model Used
	5A	MHQWW-09-H-1-U, MHQWW-12-H-1-U, MHQWW-18-H-1-U MHQWW-24-H-1-U & MHQWW-36-H-1-U
Power outlet 3 Pole	2P for the power and 1P for the earth terminal/ground.	

1. Remove the frame grille.
2. Open the control box cover by loosening the screw.
3. Loosen the wire clamp screws
4. Connect the connecting cables of the power cord to the terminal block on the control box and screw it tightly.
5. Secure all field cable on to control box with wire clamp.
6. Be sure that all wiring connections comply to the wiring diagram before covering the control box.
7. Plug in the power supply cord at the power outlet, (SeePage10).

## INSTALLATION PROCEDURE

### \* WIRE CONNECTION TO THE TERMINAL BLOCK

MODEL: MHQWW-09-H-1-U, MHQWW-12-H-1-U, MHQWW-18-H-1-U  
MHQWW-24-H-1-U & MHQWW-36-H-1-U

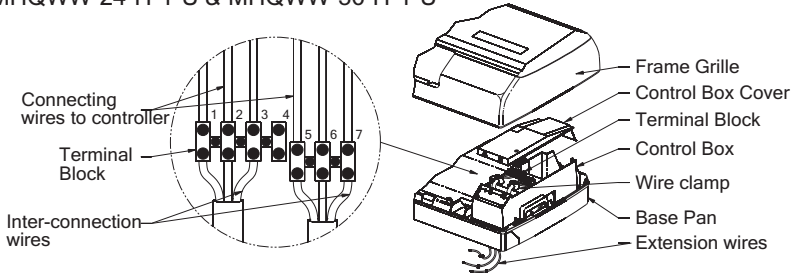

There are three extension wires (AWG18 Blue, Red and Yellow color) coming out from the fancoil terminal block for the water control valve (please refer to the wiring diagram).

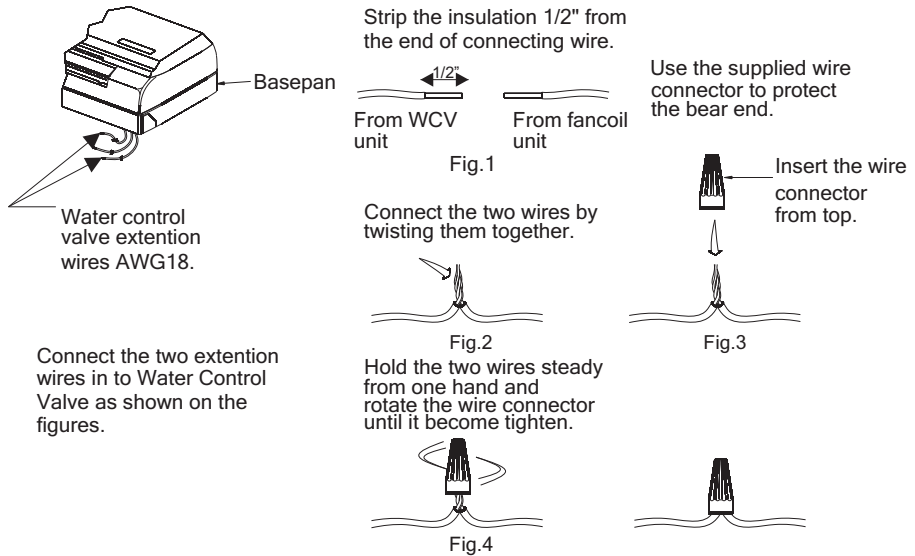

## THERMOSTAT CONTROLLER INSTALLATION GUIDE

### \* MOUNTING LOCATION

Mount the thermostat approx. 5ft. (1.5m) above the floor in a location that is free from direct sunlight, heat from appliances, hot or cold air from ducts, concealed pipes and chimneys, and drafts of dead spots behind doors or in a corner. Do not mount on exterior wall, if possible. Failure to locate thermostat mounting as indicated may result in poor temperature control.

### \* INSTALLATION

Read these instructions thoroughly before installing product. Failure to follow these instructions could damage the product or cause a hazardous condition. Check the voltage and current ratings to ensure that it is suitable for your application. Installer must be a trained, experienced service technician. Check product for proper operation after installation.



## CAUTION

Damage to cooling system may occur. Disconnect power from equipment at the main breaker/ fuse block while installing the thermostat.

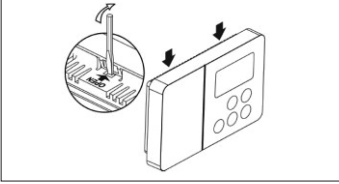

1. Lift and open top side using screw driver.

### Installation A (wires though wall)

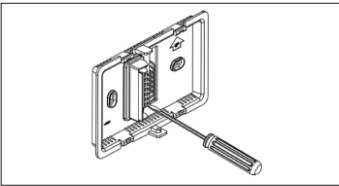

- 1.1. Use cable 0.5-1sq.mm connect the wires into terminals.

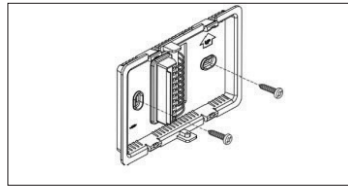

- 1.2. Installing back plate into the wall with screws.

### Installation B (wires on wall)

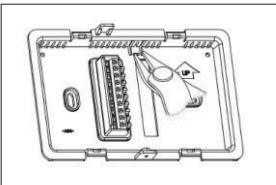

- 1.1. Cut the plastic and open hole with pliers.

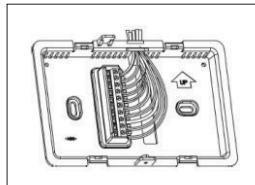

- 1.2. Use cable 0.5-1sq.mm connect the wires into terminals.

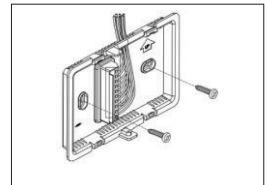

- 1.2. Install back plate into the wall with screws.

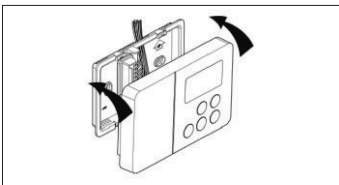

2. Install the front case, carefully inspect wiring as per diagram before mounting thermostat.

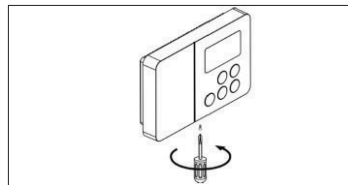

3. Tighten the screw firmly.

# WIRING DIAGRAM

**MODEL : MHQWW-09-H-1-U & MHQWW-12-H-1-U**

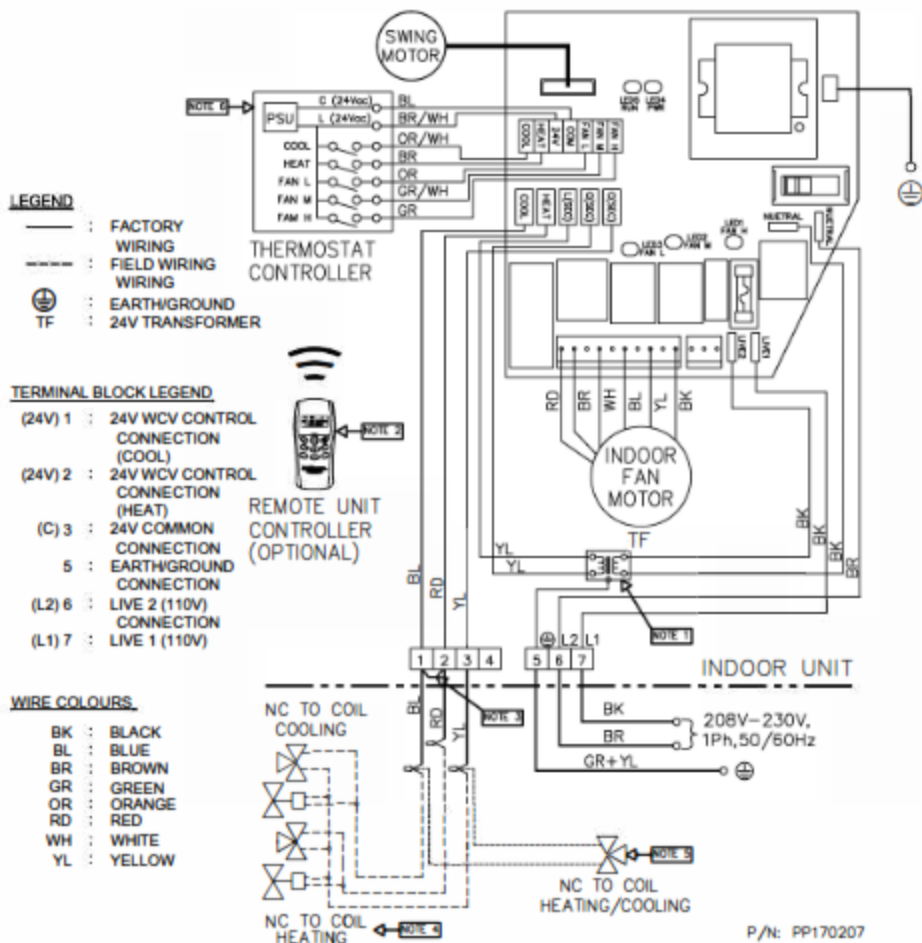

P/N: PP170207

## NOTES

1. 230V - 24Vac TRANSFORMER.
2. WIRELESS REMOTE INCLUDES A WALL MOUNTING BRACKET (OPTIONAL).
3. JUMPER MUST BE FIELD INSTALLED FOR 2-PIPE HEAT/COOL OPERATION.
4. 4-PIPE WIRING AND CONFIGURATION.
5. 2-PIPE WIRING AND VALVE CONFIGURATION.
6. THERMOSTAT CONTROLLER UNIT.
7. THE FIELD WIRING CONDUCTOR OF HIGH AND LOW VOLTAGE CIRCUIT SHALL BE SEPERATELY FIXED FIRMLY BY EACH CLAMP.
8. ALL WIRING SHALL BE DONE ACCORDING TO THE NATIONAL AND LOCAL CODE REQUIREMENTS.
9. A LINE OF SIGHT SERVICE DISCONNECT MUST BE PROVIDE AS A MEANS TO TURN OFF POWER FOR SERVICING.

Model: MHQWW-18-H-1-U & MHQWW-24-H-1-U

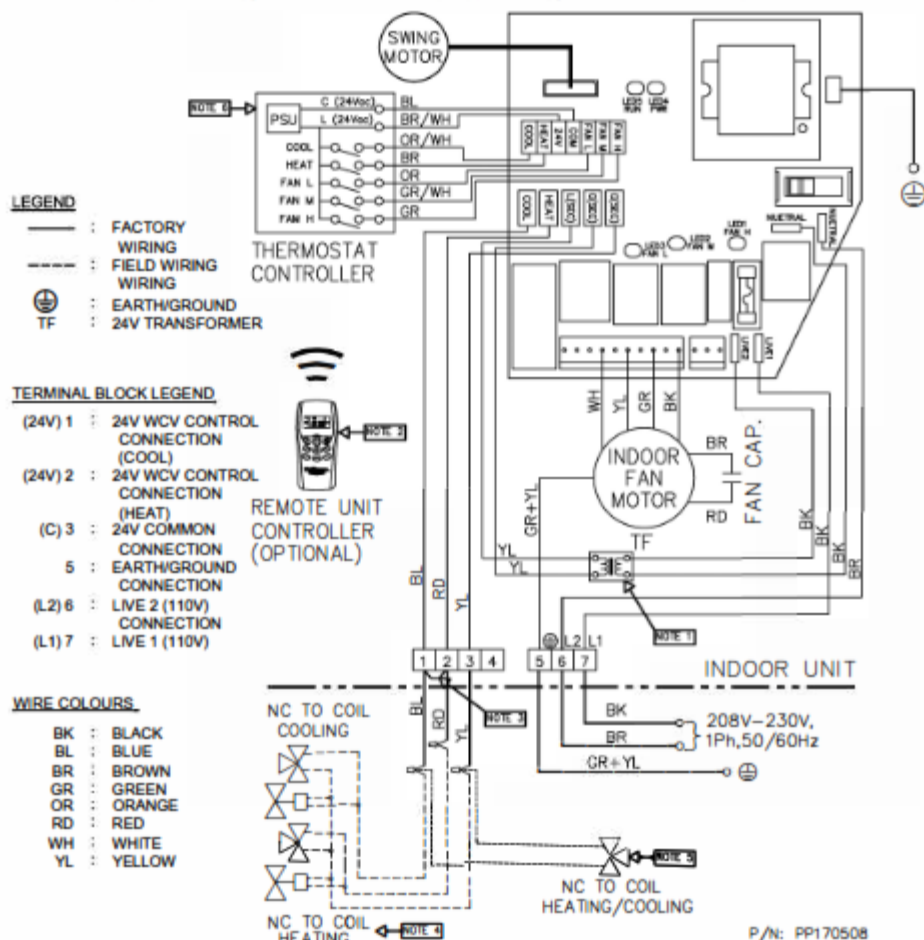

P/N: PP170508

NOTES

1. 230V - 24Vac TRANSFORMER.
2. WIRELESS REMOTE INCLUDES A WALL MOUNTING BRACKET (OPTIONAL).
3. JUMPER MUST BE FIELD INSTALLED FOR 2-PIPE HEAT/COOL OPERATION.
4. 4-PIPE WIRING AND CONFIGURATION.
5. 2-PIPE WIRING AND VALVE CONFIGURATION.
6. THERMOSTAT CONTROLLER UNIT.
7. THE FIELD WIRING CONDUCTOR OF HIGH AND LOW VOLTAGE CIRCUIT SHALL BE SEPERATELY FIXED FIRMLY BY EACH CLAMP.
8. ALL WIRING SHALL BE DONE ACCORDING TO THE NATIONAL AND LOCAL CODE REQUIREMENTS.
9. A LINE OF SIGHT SERVICE DISCONNECT MUST BE PROVIDE AS A MEANS TO TURN OFF POWER FOR SERVICING.

Model: MHQWW-36-H-1-U

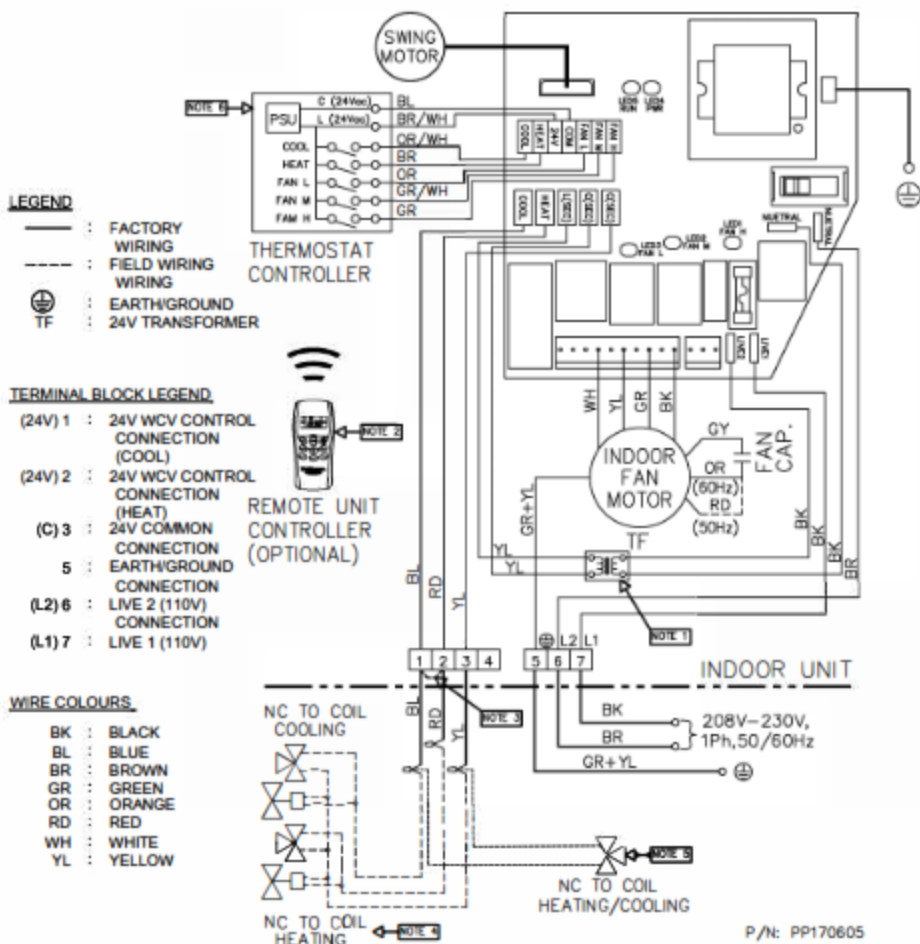

P/N: PP170605

NOTES

1. 230V - 24Vac TRANSFORMER.
2. WIRELESS REMOTE INCLUDES A WALL MOUNTING BRACKET (OPTIONAL).
3. JUMPER MUST BE FIELD INSTALLED FOR 2-PIPE HEAT/COOL OPERATION.
4. 4-PIPE WIRING AND CONFIGURATION.
5. 2-PIPE WIRING AND VALVE CONFIGURATION.
6. THERMOSTAT CONTROLLER UNIT.
7. THE FIELD WIRING CONDUCTOR OF HIGH AND LOW VOLTAGE CIRCUIT SHALL BE SEPERATELY FIXED FIRMLY BY EACH CLAMP.
8. ALL WIRING SHALL BE DONE ACCORDING TO THE NATIONAL AND LOCAL CODE REQUIREMENTS.
9. A LINE OF SIGHT SERVICE DISCONNECT MUST BE PROVIDE AS A MEANS TO TURN OFF POWER FOR SERVICING.

**\* AIR PURGING**

1. After connecting the water inlet and outlet pipes to the main water supply lines, turn on the power and turn the unit on in cooling.
2. Open the water inlet valve and flood the coil.
3. Check all connections for water leak, if no leak is found, loosen (1 turn, counter clockwise) the purging valve by using standard head screw driver and support with an open end wrench (No.10), then purge the trapped air inside the coil.



When performing this, take care not to touch the electrical parts.

4. When no air bubbles appear, close the purging valve (Clockwise)
5. Open the water outlet valve.

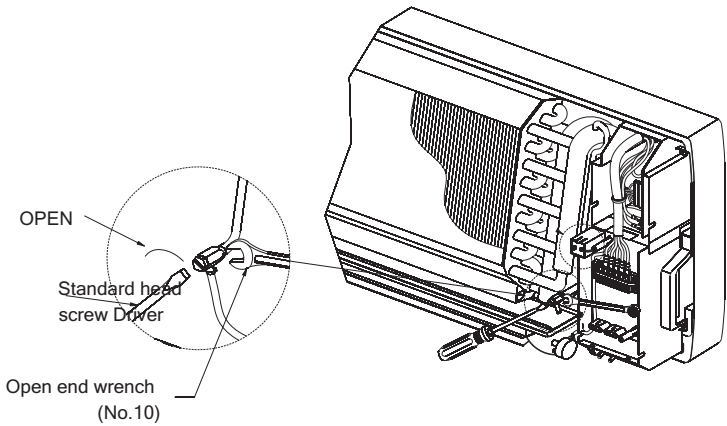

**\* HOW TO INSTALL THE FRAME GRILLE ON THE FANCOIL UNIT**

1. Install the frame grille in the opposite order of "HOW TO REMOVE THE FRAME GRILLE".  
When the frame grille is removed and mounted again, take the following actions:  
Before fastening the mounting screws be sure to hook the top inside lock of the frame grille.

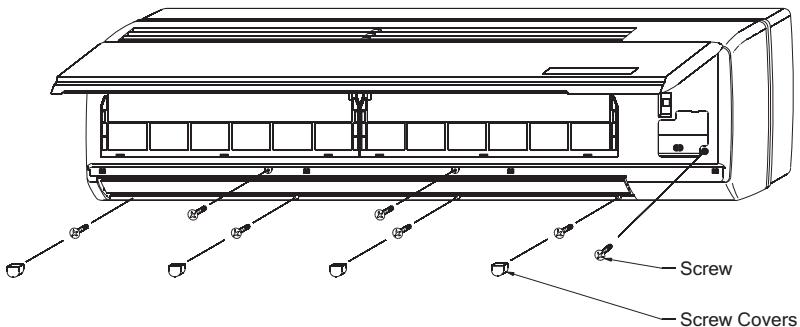

INSTALLATION PROCEDURE

2. Return the terminal cover by fastening it's screw.
3. Close and push the front panel into the frame grille until the "click" sound is heard  
 MODEL: MHQWW-09-H-1-U, MHQWW-12-H-1-U, MHQWW-18-H-1-U & MHQWW-24-H-1-U

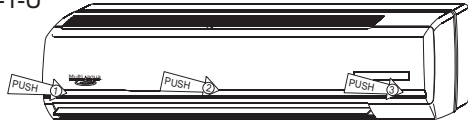

MODEL:MHQWW-36-H-1-U

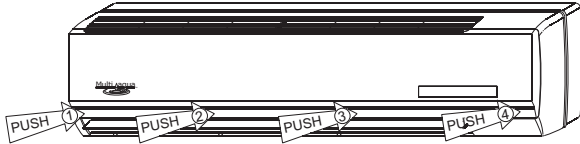

THERMOSTAT CONTROLLER OPERATION GUIDE

▪ DESCRIPTIONS AND FUNCTION OF WIRED CONTROLLER

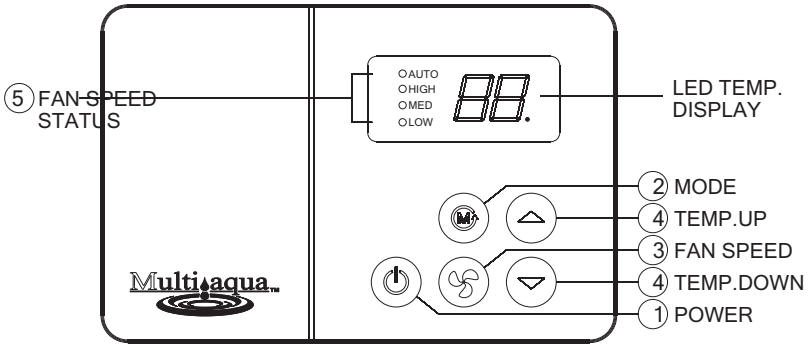

**\*FUNCTION**

**1. POWER ON/OFF**

\*Press to turn ON/OFF the air conditioner. When turned on, it will operate according to the last program setting.

**2. MODE**

For cool, heat, dry and auto functions

For other version, this is a MODE button used to select the operation mode.



Cool only mode



Heat / Cool mode



# THERMOSTAT CONTROLLER OPERATION GUIDE

- Cool mode **CO** : 7 Segment will flash for 5 seconds.  
Dry mode **dY** : 7 Segment will flash for 5 seconds.  
Fan mode **FO** : 7 Segment will flash for 5 seconds.  
Heat mode **HE** : 7 Segment will flash for 5 seconds.

- **Ho** flashing for 5 seconds if the Hot Water Pipe version is ordered.

Auto mode **AL** : 7 Segment will flash for 5 seconds.  
The system will automatically switch from Cool to Heat mode or vice versa.

## 3. FAN

Press  button to select the fan speed in the following sequence.

LED at  will show the status of the fan speed.

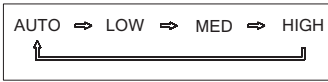

Auto mode



The Speed will be adjusted according to the difference between the room and the set temp.

If the difference is 3°C or more, the fan will run at HIGH speed.

If the difference is 2°C or more, the fan will run at MED speed.

If the difference is 1°C or more, the fan will run at LOW speed.

## 4. Temperature setting

Press  or  button for setting temperature in a range of 15-30°C or 58-88°F.  
7 segment display will show the new setting for 5 seconds.

# REMOTE CONTROLLER OPERATION GUIDE

## ▪ PREPARATION OF THE REMOTE CONTROLLER

- Open the battery cover by pressing slightly in the direction of arrow.
- Insert two 1.5Volt high performance alkaline batteries (AAA), being careful not to invert the polarity.
- Close the battery cover.

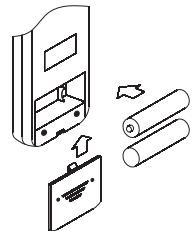

## ▪ USE OF THE REMOTE CONTROLLER

- Be sure that no obstructions between receiver and remote controller.
- The remote control signal can be received at the distance of up to about 7 Meters.
- Point the remote control unit transmitter towards the air conditioner receiver while the setting is being stabilise.
- To be able to carry out any operation or change of the setting from the remote control unit air conditioner must be powered.

\*DESCRIPTIONS AND FUNCTION OF REMOTE CONTROLLER

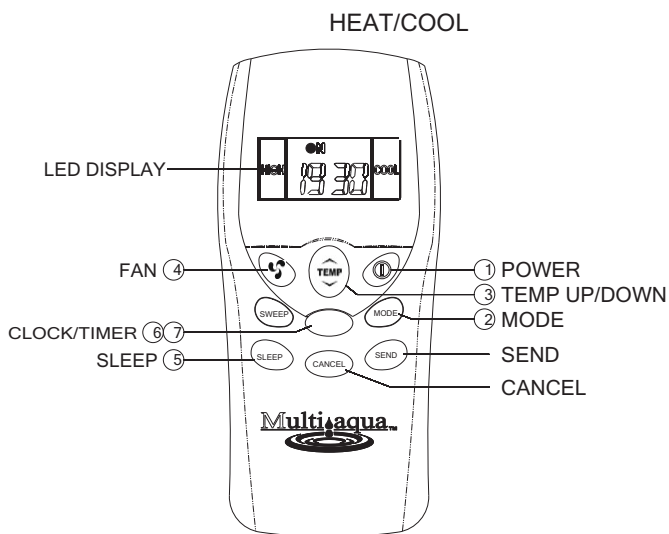

\*FUNCTION

1. POWER ON/OFF

\*Press to turn ON/OFF the air conditioner. When turned on, it will operate according to the last program setting.

2. Mode

\*Press button to change the mode of operation in the following sequence.

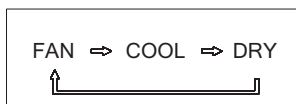

Cool only mode

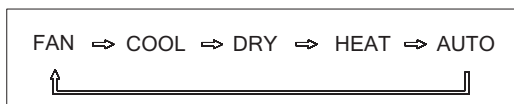

Heat/Cool mode

3. TEMPERATURE SETTING

\*Press button to set the temperature.

4. FAN

\*Press button to set the fan speed.

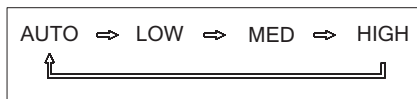



5. SLEEP

\*Press button to activate the Sleep function which will raise up/reduce the set temperature 1°C for Cool/Heat mode respectively.

## 6. CLOCK SETTING

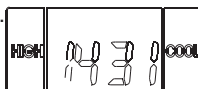

To set the clock on the Remote unit.

- Press  button until clock symbol  is blinking.
- Press  button to set the time.
- Press SEND button to confirm setting.





## 7. TIMER ON/OFF

To turn on/off the air conditioner in advance.

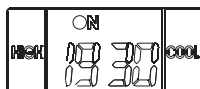
- Press  button until timer symbol On or OFF is blinking
- Press  button to set the timer.
- Press SEND button to confirm the setting.



## Remark

To cancel press  button until timer symbol is blinking, then press  button.

# START-UP NOTICE

1. Be sure that there is no obstruction in the air outlet and intake vents.
2. Check that the filter is installed.
3. Check that the power supply is connected.
4. Check that ground wire is properly connected.

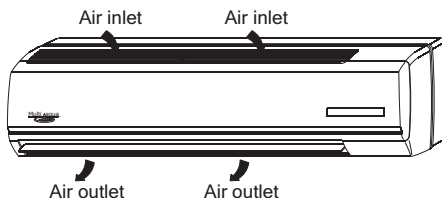

## ADJUSTING AIR FLOW DIRECTION

- The horizontal louver and air deflectors on the air delivery can be arranged in two directions:

\*Air deflectors to be oriented manually.

\*Horizontal louver to be oriented manually.

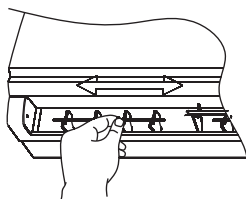

### ORIENT THE AIR DEFLECTOR:

- Turn the air deflector as indicated in the figure
- Both in Heating and Cooling mode. It is advisable for the air flow not to hit people directly.

### MOTORIZED HORIZONTAL LOUVER:

- Never orient the motorized horizontal louver manually. Any manual operation on the louver may cause damage in the system and cause malfunctioning.

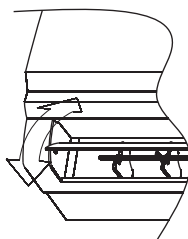

## CARE & MAINTENANCE

### WARNING

- \* Disconnect and lock out the power before making any repair or any services.
- \* Sharp edges and coil surfaces are a potential injury hazard. Avoid contact with these.

### ■ MAINTENANCE

- If you plan to leave the unit idle for a long time, perform the following:
  1. Disconnect Power.
  2. Ensure no water is moving through the unit.
  3. Remove the batteries from the remote controller.

### ■ CHECK BEFORE OPERATION

1. Check if the air filter is installed and the air outlet is not blocked.
2. Connect Power.
3. Replace the remote control batteries.

## \*CLEANING THE FAN COIL UNIT



1. External weekly cleaning is to be done with a dry cloth soaked with fresh water and mild soap, avoid using any other type of detergent.



2. The Frame grille with deco panel can be removed. Clean with warm water not over 120°F and wipe with dry cloth.



3. Do not use a chemically treated cloth or duster to clean the unit.

4. Do not use benzene, thinner, polishing chemical or similar solvents for cleaning. These may cause surface discoloration, cracks or deformation.

## \*CLEANING AIR FILTERS

\* Dirty and clogged filters reduce the cooling efficiency of the unit. It is recommended to clean the filters once every 2 weeks.

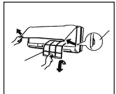

1. Open the deco panel by grasping the rounded grooves and pulling towards you.

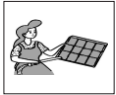

2. Hold the tabs of air filter and raise it slightly, then pull filter downwards.

3. Clean the air filters with vacuum cleaner or wash with water then dry.

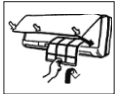

4. Do not use benzene, thinner, polishing chemical or similar solvents for cleaning. These may cause the surfaces to crack or deform.

5. Install the air filter vice versa of removing procedure. The correct filter side is indicated by words "FRONT" marked on the filter.

The "FRONT" side should be facing you.

## OPERATION TIPS

- The following events may occur during normal operation.

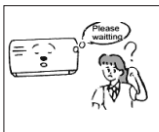

### UNIT DOES NOT OPERATE IMMEDIATELY.

If you restart the fancoil within 3 minutes of turning it off or change them during operation, a protective time delay device will work to shut off the unit for 3 minutes.



### A PECULIAR SMELL COMING FROM THE UNIT.

Odors present in the room, such as those from the carpet, furniture or smoke may be emitted from the unit.





### HEAR A HISSING SOUND DURING OPERATION.

A soft, swishing noise can be heard during operation or immediately after the unit is turned ON or OFF. This is the sound of circulating cooling/heat agent. It may also be air trapped in the piping loop.

# TROUBLE SHOOTING GUIDE

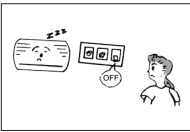
- If the unit appears to be malfunctioning, check the following points before calling for service.

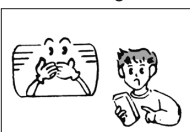
PROBLEM	PROBLEM CAUSE	REMEDY
<p>1. Air conditioner doesn't operate.</p> 	<ol style="list-style-type: none"> <li>1. Has power been shutdown or has power failure occurred?</li> <li>2. Is the wiring connection loose?</li> <li>3. Is the power protection in operation?</li> <li>4. Is the fuse blown or circuit breaker open?</li> </ol>	<ol style="list-style-type: none"> <li>1. Wait for power to resume.</li> <li>2. Tighten the connection.</li> <li>3. Reset the power button.</li> <li>4. Replace fuse or reset the circuit breaker.</li> </ol>
<p>2. In sufficient Cooling or Heating.</p> 	<ol style="list-style-type: none"> <li>1. Is the set temperature suitable?</li> <li>2. Is air inlet or outlet obstructed?</li> <li>3. Are filters dirty?</li> <li>4. Is there any other heat source in the room?</li> <li>5. Is there a large number of people in the room?</li> </ol>	<ol style="list-style-type: none"> <li>1. Reset suitable set temperature.</li> <li>2. Remove objects that obstruct the air inlet and outlet.</li> <li>3. Clean filters and other part.</li> </ol>
<p>3. Wireless remote controller is not functioning.</p> 	<ol style="list-style-type: none"> <li>1. Is the remote control unit out of effective distance from the thermostat?</li> <li>2. Are there any obstructions between the remote controller and thermostat?</li> <li>3. Are the batteries low?</li> </ol>	<ol style="list-style-type: none"> <li>1. Use the remote controller within sufficient distance of the thermostat.</li> <li>2. Remove or clean the obstruction.</li> <li>3. Replace with new batteries.</li> </ol>

- Problems that needs qualified personnel assistance.

PROBLEM	PROBLEM CAUSE	REMEDY
<p>1. Air conditioner doesn't run.</p>	<ol style="list-style-type: none"> <li>1. Faulty transformer, relay and/or fan motor capacitor.</li> <li>2. Control board not functioning.</li> <li>3. Terminal loose.</li> <li>4. Is water valve or circulator functioning?</li> </ol>	<ol style="list-style-type: none"> <li>1. Replace faulty components.</li> <li>2. Check the cause of malfunctioning and replace control board if necessary.</li> <li>3. Check and retighten any loose terminals.</li> <li>4. Check to see if water valve or circulator is opening or actuating.</li> </ol>

## IMPORTANT INFORMATION

### WARNING

- The unit is connected to the power supply. Operations performed by persons without the required technical skills can lead to personal injury or damage to the unit and surrounding objects.

### MALFUNCTIONING

- In the case of malfunctioning, remove power to the unit then repower and start the unit again. If the problems persists, call service personnel promptly.



Ensure voltage, amperage and Hz comply with the fancoil nameplate data. Failure to do so, will cause permanent damage to the unit.

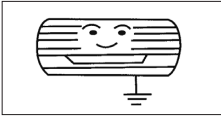

The ground must be connected. Do not connect the ground wire to water pipes, gas pipes, lighting rods or telephone ground wire.



Select the most appropriate temperature to provide maximum comfort in room. The room should be kept at least 9°F below outdoor ambient. Careful choice of the room temperature will lead to energy savings.

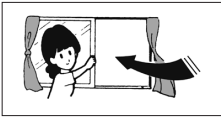

Do not leave windows and doors open while operating the air conditioner. During operation, always leave the filters in the unit, other wise the dust in the air could soil the surface of the evaporator coil.

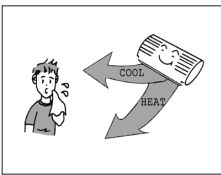

The air direction can be adjusted appropriately. The air coming out of the unit must not strike people directly. This could cause a cold sensation and result in discomfort. Adjust the air deflect manually.



Do not put anything in the air inlets or outlet slot. This could cause injury to people and damage to the unit.

Splashing water on the air conditioner can cause electrical shock and / or fancoil malfunction.



MULTIAQUA, INC.

306 Hagood St. Easley, SC 29640

Tel.:(864)850-8990 Fax:(864)850-8995 e-mail: support@multiaqua.com

[www.multiaqua.com](http://www.multiaqua.com)